

Varenummer: 3901250030200
 Beskrivelse: Snekkegear med fri indgangsaksel
 VF 250A-30-HS

Mål

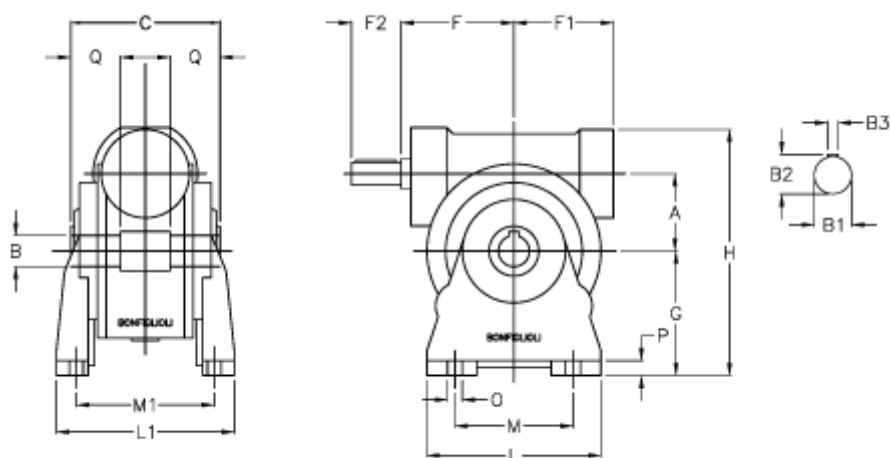

a	= 250.0	F1	= 318	P	= 30
B	= 110	g	= 380	Q	= 85.0
B1 E7	= 55	H	= 750		
B2	= 59.0	L	= 520		
B3 H9	= 16	L1	= 380		
Betegnelse	= VF 250A-xx-HS	m	= 400		
C	= 320	M1	= 310.0		
F	= 276.0	O	= 33.0		